



# Microwave Oven

(COMMERCIAL)

Owner's Instructions & Cooking Guide

**Planet  
First** 100%  
Recycled Paper

This manual is made with 100% recycled paper.

CM1929A (1850 WATT)  
CM1529A (1500 WATT)  
CM1329A (1300 WATT)

imagine the possibilities

Thank you for purchasing this Samsung product.  
Please register your product at

[www.samsung.com/register](http://www.samsung.com/register)

CE

**SAMSUNG**



## CONTENTS

Oven .....	2
Control Panel.....	3
Display .....	3
Using this instruction booklet .....	3
Important safety information .....	3
Legend for symbols and icons .....	4
PRECAUTIONS TO AVOID POSSIBLE EXPOSURE TO EXCESSIVE MICROWAVE ENERGY.....	4
Important safety instructions.....	4
Correct disposal of this product (waste electrical & electronic equipment).....	6
Cooking Instructions.....	7
Cooking/Reheating.....	7
Power levels and Time Variations.....	9
Stopping the cooking .....	9
Repeat Feature.....	9
Using +20sec Pad.....	10
Using the Defrost Feature .....	10
Memory Pads Programming .....	11
How to Operate Memory Cooking .....	13
How to Operate Double Quantity Pad.....	13
Double Quantity Pad Programming.....	13
Controlling Beep Tone .....	14
Programming Air Filter Clean Time.....	14
Error Codes.....	15
Hidden Keys.....	15
Care of Your Microwave Oven.....	16
Cleaning the Ceiling Cover.....	16
Cleaning the Air Filter .....	16
Installation Instructions for Stacking.....	17
Replacement of Lamp .....	17
Cookware guide .....	18
Cleaning your microwave oven .....	22
Storing and repairing your microwave oven.....	22
Technical specifications .....	23

## OVEN

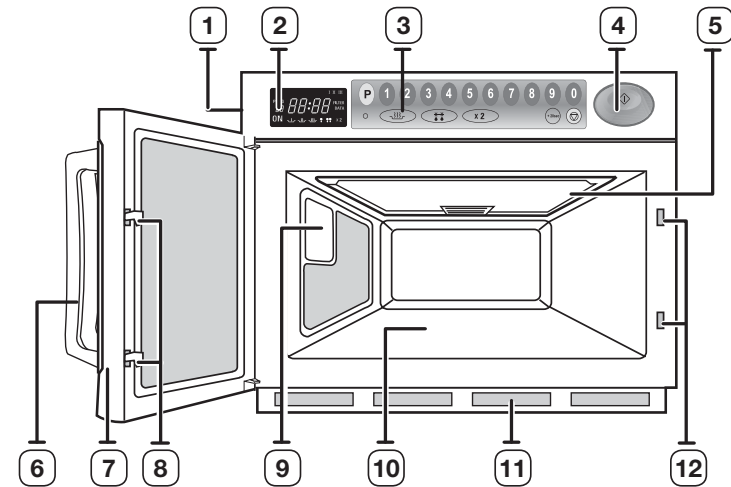

- |                    |                            |
|--------------------|----------------------------|
| 1. OVEN LAMP COVER | 7. DOOR                    |
| 2. DISPLAY         | 8. DOOR LATCHES            |
| 3. CONTROL PANEL   | 9. OVEN LAMP               |
| 4. START BUTTON    | 10. PLATE TRAY             |
| 5. CEILING COVER   | 11. AIR FILTER             |
| 6. DOOR HANDLE     | 12. SAFETY INTERLOCK HOLES |

## CONTROL PANEL

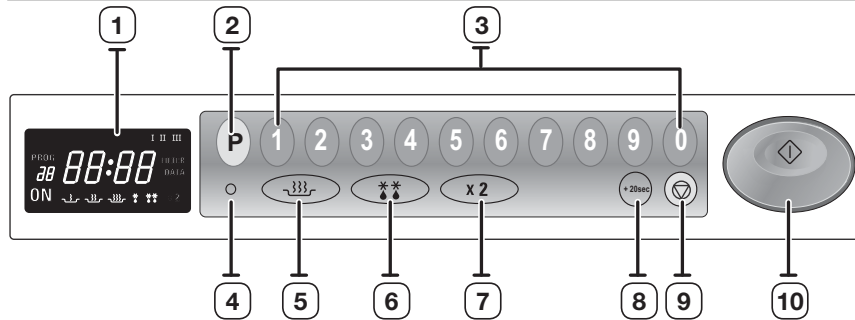

- |   |                                    |
|---|------------------------------------|
| 1. DISPLAY                                | 6. DEFROST SELECTOR PAD            |
| 2. PROGRAM PAD                            | 7. DOUBLE QUANTITY PAD             |
| 3. NUMBER PADS (Time, Memory Programming) | 8. +20sec PAD (One Touch Cook Pad) |
| 4. PROGRAM LOCK PAD                       | 9. CANCEL PAD                      |
| 5. POWER LEVEL SELECTOR PAD               | 10. START BUTTON                   |

## DISPLAY

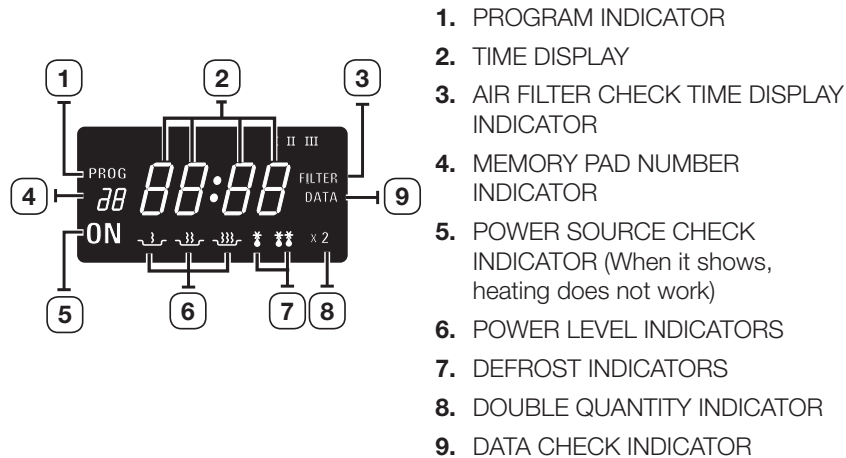

## USING THIS INSTRUCTION BOOKLET

You have just purchased a SAMSUNG microwave oven. Your Owner's Instructions contain valuable information on cooking with your microwave oven:

- Safety precautions
- Suitable accessories and cookware
- Useful cooking tips
- Cooking tips

## IMPORTANT SAFETY INFORMATION

### IMPORTANT SAFETY INSTRUCTIONS.

### READ CAREFULLY AND KEEP FOR FUTURE REFERENCE.

**Before using the oven, confirm that the following instructions are followed.**

- Use this appliance only for its intended purpose as described in this instruction manual. Warnings and Important Safety Instructions in this manual do not cover all possible conditions and situations that may occur. It is your responsibility to use common sense, caution, and care when installing, maintaining, and operating your appliance.
- Because these following operating instructions cover various models, the characteristics of your microwave oven may differ slightly from those described in this manual and not all warning signs may be applicable. If you have any questions or concerns, contact your nearest service centre or find help and information online at [www.samsung.com](http://www.samsung.com).
- This microwave oven is supposed for heating food. It is intended for domestic home-use only. Do not heat any type of textiles or cushions filled with grains, which could cause burns and fire. The manufacturer cannot be held liable for damage caused by improper or incorrect use of the appliance.
- Failure to maintain the oven in a clean condition could lead to deterioration of the surface that could adversely affect the life of the appliance and possible result in a hazardous situation.

This product is a Group 2 Class B ISM equipment. The definition of group 2 which contains all ISM equipment in which radio-frequency energy is intentionally generated and/or used in the form of electromagnetic radiation for the treatment of material, and EDM and arc welding equipment. For Class B equipment is equipment suitable for use in domestic establishments and in establishments directly connected to a low voltage power supply network which supplies buildings used for domestic purposes

## LEGEND FOR SYMBOLS AND ICONS

 **WARNING** Hazards or unsafe practices that may result in **severe personal injury or death.**

 **CAUTION** Hazards or unsafe practices that may result in minor personal injury or property damage.

 Warning; Fire hazard

 Warning; Electricity

 Do NOT attempt.

 Do NOT disassemble.

 Do NOT touch.

 Call the service center for help.

 Important

 Warning; Hot surface

 Warning; Explosive material

 Follow directions explicitly.

 Unplug the power plug from the wall socket. Make sure the machine is grounded to prevent electric shock.

 Make sure the machine is grounded to prevent electric shock.

 Note

## PRECAUTIONS TO AVOID POSSIBLE EXPOSURE TO EXCESSIVE MICROWAVE ENERGY

Failure to observe the following safety precautions may result in harmful exposure to microwave energy.

(a) Under no circumstances should any attempt be made to operate the oven with the door open or to tamper with the safety interlocks (door latches) or to insert anything into the safety interlock holes.

(b) Do not place any object between the oven door and front face or allow food or cleaner residues to accumulate on sealing surfaces. Ensure that the door and door sealing surfaces are kept clean by wiping after use first with a damp cloth and then with a soft dry cloth.



















(c) Do not operate the oven if it is damaged until it has been repaired by a qualified microwave service technician trained by the manufacturer. It is particularly important that the oven door closes properly and that there is no damage to the:

- (1) Door (bent)
- (2) Door hinges (broken or loose)
- (3) door seals and sealing surfaces

(d) The oven should not be adjusted or repaired by anyone other than a properly qualified microwave service technician trained by the manufacturer.

## IMPORTANT SAFETY INSTRUCTIONS

Make sure that these safety precautions are obeyed at all times.

 <b>WARNING</b>				
 Only qualified staff should be allowed to modify or repair the microwave oven.	✓	✓	✓	✓
 Do not heat liquids and other food in sealed containers.	✓	✓	✓	✓
 Do not install this appliance; near heater, inflammable material; in a humid, oily or dusty location, in a location exposed to direct sunlight and water or where gas may leak; on a level ground.	✓	✓	✓	✓
 This appliance must be properly grounded in accordance with local and national codes.	✓	✓	✓	✓
 Remove all foreign substances such as dust or water from the power plug terminals and contact points using a dry cloth on a regular basis.	✓	✓	✓	✓
 Do not pull or excessively bend or place heavy object on the power cord.	✓	✓	✓	✓
 In the event of a gas leak (such as propane gas, LP gas, etc.), ventilate immediately without touching the power plug.	✓	✓	✓	✓
 Do not touch the power plug with wet hands.	✓	✓	✓	✓
 Do not turn the appliance off by unplugging the power plug while an operation is in progress.	✓	✓	✓	✓
 Do not insert fingers or foreign substances, If any foreign substance such as water has entered the appliance, unplug the power plug and contact your nearest service centre.	✓	✓	✓	✓
 Do not apply excessive pressure or impact to the appliance.	✓	✓	✓	✓
 Do not place the oven over a fragile object such as a sink or glass object. (Counter top model only)	✓	✓		
 Do not use benzene, thinner, alcohol, steam cleaner or high pressure cleaner to clean the appliance.	✓	✓	✓	✓

<input type="checkbox"/>	Ensure that the power voltage, frequency and current are the same as those of the product specifications.	✓	✓		✓
<input type="checkbox"/>	Plug the power plug into the wall socket firmly. Do not use a multiple plug adapter, an extension cord or an electric transformer.	✓	✓	✓	
<input type="checkbox"/>	Do not hook the power cord on a metal object, insert the power cord between the objects or behind the oven.	✓	✓	✓	
<input type="checkbox"/>	Do not use a damaged power plug, damaged power cord or loose wall socket. When the power plug or power cord is damaged, contact your nearest service centre.	✓	✓	✓	✓
<input type="checkbox"/>	Appliances are not intended to be operated by means of an external timer or separate remote-control system.	✓	✓		
<input type="checkbox"/>	Do not pour or directly spray water onto the oven.	✓	✓		
<input type="checkbox"/>	Do not place objects on the oven, inside or on the door of the oven.	✓	✓	✓	
<input type="checkbox"/>	Do not spray volatile material such as insecticide onto the surface of the oven.	✓	✓		
<input checked="" type="checkbox"/>	Children should be supervised to ensure that they do not play with the appliance	✓	✓	✓	✓
<input type="checkbox"/>	The appliance is not intended for installing in road vehicles, caravans and similar vehicles etc.	✓	✓	✓	✓
<input type="checkbox"/>	Do not store flammable materials in the oven. Take special care when heating dishes or drinks that contain alcohol as alcohol vapours may contact a hot part of the oven.	✓		✓	✓
<input type="checkbox"/>	The microwave oven is intended to be used on the counter or counter top use only, the microwave oven shall not be placed in a cabinet. (Counter top model only)	✓	✓	✓	✓
<input checked="" type="checkbox"/>	<b>WARNING:</b> Only allow children to use the oven without supervision when adequate instructions have been given so that the child is able to use the oven in a safe way and understands the hazards of improper use.	✓	✓	✓	✓
<input type="checkbox"/>	<b>WARNING:</b> If the door or door seals are damaged, the oven must not be operated until it has been repaired by a competent person.	✓	✓	✓	✓

<input type="checkbox"/>	<b>WARNING:</b> It is hazardous for anyone other than a competent person to carry out any service or repair operation that involves the removal of a cover which gives protection against exposure to microwave energy.	✓	✓	✓	✓
<input type="checkbox"/>	<b>WARNING:</b> Liquids and other foods must not be heated in sealed containers since they are liable to explode.	✓		✓	✓
<input checked="" type="checkbox"/>	<b>WARNING:</b> Microwave heating of beverages can result in delayed eruptive boiling, therefore care must be taken when handling the container; To prevent this situation ALWAYS allow a standing time of at least 20 seconds after the oven has been switched off so that the temperature can equalize. Stir during heating, if necessary, and ALWAYS stir after heating. In the event of scalding, follow these FIRST AID instructions: <ul style="list-style-type: none"> <li>Immerse the scalded area in cold water for at least 10 minutes.</li> <li>Cover with a clean, dry dressing.</li> <li>Do not apply any creams, oils or lotions.</li> </ul>	✓	✓	✓	✓
<input checked="" type="checkbox"/>	<b>WARNING:</b> The contents of feeding bottles and baby food jars shall be stirred or shaken and the temperature checked before consumption, in order to avoid burns;			✓	
<input checked="" type="checkbox"/>	The appliance is not intended for use by persons (including children) with reduced physical, sensory or mental capabilities, or lack of experience and knowledge, unless they have been given supervision or instruction concerning use of the appliance by a person responsible for their safety.	✓	✓	✓	✓
<input checked="" type="checkbox"/>	This oven should be positioned proper direction and height permitting easy access to cavity and control area.	✓	✓	✓	✓
<input checked="" type="checkbox"/>	Before using the your oven first time, oven should be operated with the water during 10 minute and then used.	✓	✓	✓	✓
<input checked="" type="checkbox"/>	This microwave oven has to be positioned so that plug is accessible. If the oven generates a strange noise, a burning smell, or smoke is emitted, unplug the power plug immediately and contact your nearest service center.	✓	✓	✓	✓

★	Appliance should allow to disconnection of the appliance from the supply after installation. The disconnection may be achieved by having the plug accessible or by incorporating a switch in the fixed wiring in accordance with the wiring rules. (Built-in model only.)	✓	✓	✓	✓
<b>⚠ CAUTION</b>					
★	Only use utensils that are suitable for use in microwave ovens; DO NOT use any metallic containers, Dinnerware with gold or silver trimmings, Skewers, forks, etc. Remove wire twist ties from paper or plastic bags. Reason: Electric arcing or sparking may occur and may damage the oven.	✓		✓	✓
★	When heating food in plastic or paper containers, keep an eye on the oven due to the possibility of ignition;	✓		✓	
⊘	Do not use your microwave oven to dry papers or clothes.	✓		✓	✓
★	Use shorter times for smaller amounts of food to prevent overheating and burning food.	✓		✓	✓
⊘	If smoke is observed, switch off or unplug the appliance and keep the door closed in order to stifle any flames;	✓		✓	✓
★	The oven should be cleaned regularly and any food deposits removed;	✓	✓		✓
⊘	Do not immerse the power cable or power plug in water and keep the power cable away from heat.	✓	✓		
⊘	Eggs in their shell and whole hard-boiled eggs should not be heated in microwave ovens since they may explode, even after microwave heating has ended; Also do not heat airtight or vacuum-sealed bottles, jars, containers, nuts in shells, tomatoes etc.			✓	✓
⊘	Do not cover the ventilation slots with cloth or paper. They may catch fire as hot air escapes from the oven. The oven may also overheat and switch itself off automatically, and will remain off until it cools sufficiently.	✓		✓	

⊘	Always use oven mitts when removing a dish from the oven to avoid unintentional burns.			✓	
⊘	Do not touch heating elements or interior oven walls until the oven has cooled down.			✓	
★	Stir liquids halfway during heating or after heating ends and allow the liquid stand at least 20 seconds after heating to prevent eruptive boiling.			✓	
★	Stand at arms length from the oven when opening the door to avoid getting scalded by escaping hot air or steam.			✓	
⊘	Do not operate the microwave oven when it is empty. The microwave oven will automatically shut down for 30 minutes for safety purposes. We recommend placing a glass of water inside the oven at all times to absorb microwave energy in case the microwave oven is started accidentally.	✓			✓
★	Install the oven in compliance with the clearances stated in this manual (see Installing Your Microwave Oven)	✓		✓	
★	Take care when connecting other electrical appliances to sockets near the oven.	✓	✓	✓	

**CORRECT DISPOSAL OF THIS PRODUCT (WASTE ELECTRICAL & ELECTRONIC EQUIPMENT)**

(Applicable in the European Union and other European countries with separate collection systems)  
 This marking on the product, accessories or literature indicates that the product and its electronic accessories (e.g. charger, headset, USB cable) should not be disposed of with other household waste at the end of their working life. To prevent possible harm to the environment or human health from uncontrolled waste disposal, please separate these items from other types of waste and recycle them responsibly to promote the sustainable reuse of material resources.  
 Household users should contact either the retailer where they purchased this product, or their local government office, for details of where and how they can take these items for environmentally safe recycling.  
 Business users should contact their supplier and check the terms and conditions of the purchase contract. This product and its electronic accessories should not be mixed with other commercial wastes for disposal.



## COOKING INSTRUCTIONS

The IEC Power Output rating is an internationally standardised rating, so all microwave manufacturers now use the same method of measuring power output.

If food packaging gives cooking instructions based on IEC Power ratings, set cooking times according to the IEC Power of your oven.

For example :

If the cooking instructions are based on a 650W oven, then you will need to reduce

some cooking time for the MW87L (850W) Ready meals are now very convenient and popular. These are meals which are already prepared and cooked by the food manufacturer, and then frozen, chilled or vacuum sealed for long life. Increasingly, heating times for such ready meals are being based on the Heating Categories A, B, C, D and E.

On this instance, simply match the heating category of your oven to the instructions on the food package, and set your timer accordingly.

For example : If the heating instructions are 3 minutes on HIGH for a D category oven, then you will need to set your timer for less than 3 minutes on HIGH for the CM1929 (E category).

- Always remember that cooking instructions are intended only as a guide. If you have followed the instructions and the food is still not piping hot throughout, simply return it to the oven and cook it until it is.

## COOKING/REHEATING

### One-stage cooking

Make sure the oven is plugged into a properly earthed electrical outlet and "ON" appears in the display window.

Open the door(The oven lamp will be turned on.).

Put the food into a suitable container, place it in the centre of the oven and then close the door securely (The oven lamp will go off.).

1. Select the desired power level by pressing the **Power Level Selector** pad.

**Result :** The selected power level will be displayed in the display window.

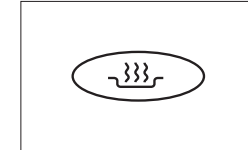

2. Set the desired heating time by pressing the **NUMBER** pads.

**Result :** The selected time is displayed in the display window.



- The maximum time according to each cooking power level can be referred to in the title "Power Levels and Time Variations" on page 7. The **NUMBER** pads will not operate or respond when you press a cooking time exceeding the maximum value. It is not possible to set a cooking time longer than the maximum time allowed on the chosen program. It is advisable to press **CANCEL** and to enter a new power level and cooking time.





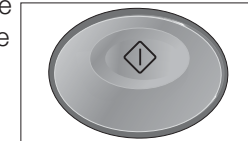
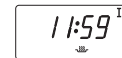

3. Press the **Start** button.

**Result :** The oven lamp and cooling fan will be turned on. Heating will start. The time on digital display will count down.



- When all time is elapsed, the end of cycle Beep Tone will sound 4 times and all heating will stop. The oven lamp will go off. For 1 min, the display shows '0' and the cooling fan will keep working in order to cool down the interior parts. During the time, the fan will not stop even when you open the door. 1 min later it will stop. Food may be removed from oven whilst the fan is still running. During the time, the fan will not stop even when you open the door. 1 min later it will stop and "ON" appears again. Food may be removed from oven whilst the fan is still running.

4. Open the door and take the food out.  
Close the door. The oven lamp will go off.

Whilst in a heating cycle, one press on (  ) pad stops the oven. At this time, the Power Check Indicator "ON" starts blinking and goes off when the (  ) pad or (  ) button is pressed again. You can restart it by pressing the (  ) button or a second press on (  ) pad will cancel the selected program. While NOT in a heating cycle, one tap on (  ) pad cancels the selected program. You can press +20sec pad one or more times in order to add the cooking time by 20 seconds. But you can not exceed the maximum time per power level allowed for power level selected.

When you first plug in the power cord, the oven beeps once and all the indicators show for 5 sec in the display window.

When heating cycle is completed and you open the door, the oven lamp automatically turns on and goes off 1 min later.

When you open the door whilst in a heating cycle, the oven stops operating and the oven lamp automatically turns on for 1 min and goes off 1 min later. If you leave the oven door open for more than 1 min, the oven beeps once every minute and after 5 min the power source check indicator 'ON' appears in the display window.

### Multi-stage cooking

1. Select the desired power level by pressing the **POWER LEVEL** Selector pad or **DEFROST** pad.

**Result :** The selected power level will be displayed in the display window.

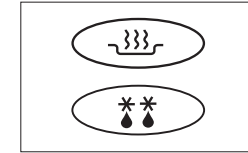

2. Set the desired heating time by pressing the **NUMBER** pads.

**Result :** The selected time is displayed in the display window.



The maximum time according to each cooking power level can be referred to in the title "Power Levels and Time Variations" on page 7. The **NUMBER** pads will not operate or respond when you press a cooking time exceeding the maximum value. It is not possible to set a cooking time for longer than the maximum time allowed on the chosen program. It is advisable to press **CANCEL** and to enter a new power level and cooking time.

3. Repeat steps 1 and 2 for II or III stage memory programming.

4. Press the  button.

**Result :** The oven lamp and cooling fan will be turned

on. The oven will automatically start heating according to pre-programed cooking time and power level.(I stage → II stage → III stage). The time on digital display will count down.

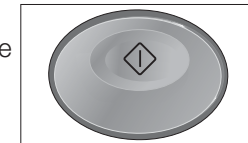
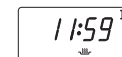

-  You can not set up the same **POWER LEVEL** or **DEFROST**.
-  It operates as setting up sequence.



## POWER LEVELS AND TIME VARIATIONS

The power level function enables you to adapt the amount of energy dissipated and thus the time required to cook or reheat your food, according to its type and quantity. You can choose between the power levels below.

Power level	CM1929A		CM1529A		CM1329A	
	Percentage	Output	Percentage	Output	Percentage	Output
HIGH (عالي)	100 %	1850 W	100 %	1500 W	100 %	1300 W
MEDIUM (متوسط)	70 %	1295 W	70 %	1050 W	70 %	910 W
LOW (منخفض)	50 %	925 W	50 %	750 W	50 %	650 W
HIGH DEFROST (عالي ذوب)	20 %	370 W	25 %	375 W	30 %	390 W
LOW DEFROST (منخفض ذوب)	10 %	185 W	13 %	195 W	15 %	195 W

The cooking times given in recipes and in this booklet correspond to the specific power level indicated.

Power level	Max. Time
HIGH (عالي)	25 mins
MEDIUM (متوسط)	40 mins
LOW (منخفض)	40 mins
HIGH DEFROST (عالي ذوب)	50 mins
LOW DEFROST (منخفض ذوب)	50 mins

## STOPPING THE COOKING

You can stop cooking at any time so that you can:

- Check the food
- Turn the food over or stir it
- Leave it to stand

To stop the cooking...	Then...
<b>Temporarily</b>	Open the door or press (⏏) pad once. <b>Result :</b> Cooking stops. To resume cooking, close the door and press (⏏) again.
<b>Completely</b>	Press the (⏏) pad twice. <b>Result :</b> The cooking settings are cancelled.

 If you want to cancel any cooking settings before starting cooking, simply press **CANCEL** (⏏) once.

## REPEAT FEATURE

1. You can repeat the previous cooking setting (regardless of manual or automatic memory heating) by pressing the **START** (⏏) button. The oven starts with exactly the same heating time and power level that were used in the last operation.

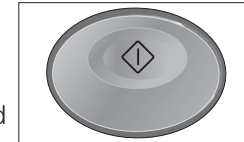

2. The repeat feature will be cancelled once the power source is cut off.

## USING +20SEC PAD

This is a **ONE TOUCH COOK** pad.

By touching the pad once, you can start heating instantly.

You can increase the cooking time by pressing the +20sec pad while heating is being done.

A cooking time increases by 20 seconds at each press on +20sec pad.

But it can not exceed the maximum time.

Like traditional cooking, you may find that, depending on the food's characteristics or your tastes, you have to adjust the cooking times slightly.

You can:

- Check how cooking is progressing at any time simply by
- opening the door
- Close the door
- Increase the remaining cooking time.

Before operating the oven, times can be increased/ decreased using either the time pads or **+20sec** button. During the operating, time may only be added by using the **+20sec** button.

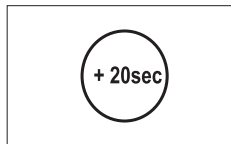

## USING THE DEFROST FEATURE

The Defrost feature enables you to defrost meat, poultry or fish.

Only use containers that are microwave-safe.

Open the door. Place the frozen food in the centre of the plate tray. Close the door.

1. Press the Defrost selector pad to set **DEFROST HIGH** ( ) or **DEFROST LOW** ( ) as you wish.

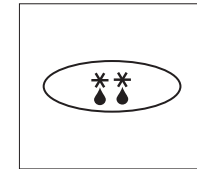

**Result :** The **DEFROST** indicator appears in the display.



2. Press the **NUMBER** pads to set the defrosting time. (Max. 50 min)



3. Press the button.

**Result :** Defrosting begins.

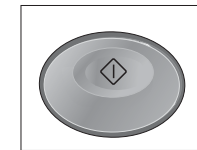
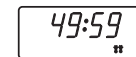

It is not possible to set a defrosting time for longer than 50min. The defrost indicator will flash and it is advisable to press **CANCEL** ( ) and enter a new defrost level and time.

When the oven was operating for longer than 25 min under Defrosting cycle, you can NOT change the power level from Defrosting to Heating(Cooking/Reheating) mode.

## MEMORY PADS PROGRAMMING

### One-stage

1. Hold down **PROGRAM LOCK** (○) and then press **PROGRAM** (P) pad. Hold together for 2 sec.

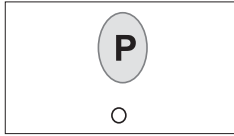

Be sure to press the pads firmly.

**Result :** **PROG** indicator appears in the digital display.



2. Press appropriate **NUMBER** pad for the desired memory number.

**Result :** Selected memory program code appears below the **PROGRAM** indicator.

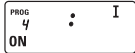

3. Select power level by pressing the **POWER LEVEL** pad or **DEFROST** pad.

**Result :** Default power level HIGH appears in the display at first press of the **POWER LEVEL** pad.

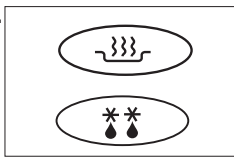

Press the **POWER LEVEL** pad or **DEFROST** pad one or more times until you get the desired power level.



4. Press **NUMBER** pads to set the cooking time.

The maximum time according to each cooking power level can be referred to in the title "Power Levels and Time Variations" on page 7. The **NUMBER** pads will not operate or respond when you press a cooking time exceeding the maximum value.

It is not possible to set a cooking time for longer than the maximum time allowed on the chosen program. It is advisable to press **CANCEL** and to enter a new power level and cooking time.



5. Hold down **PROGRAM LOCK** (○) and then press **PROGRAM** (P) pad. Hold together for 2 sec once again.

**Result :** PROG indicator and memory number indicator blink 3 times in the digital display with a beep sound. And then the display goes blank.

Caution: Be sure to press the pads firmly in the right position.



6. When you want to program more, repeat the procedures above again.

Memory programs are available up to 30 items. Make sure the unit is properly programmed. After programming is finished, all you have to do for memory cooking is to press the **NUMBER** pad. Then the selected memory program automatically starts cooking.

**Multi-stage**

1. Hold down **PROGRAM LOCK** (○) and then press **PROGRAM (P)** pad. Hold together for 2 sec.

 Be sure to press the pads firmly.

**Result :** **PROG** indicator appears in the digital display.

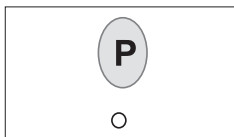
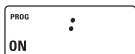

2. Press appropriate **NUMBER** pad for the desired memory number.

**Result :** Selected memory program code appears below the **PROGRAM** indicator.

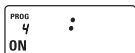

3. Select power level by pressing the **POWER LEVEL** pad or **DEFROST** pad.

**Result :** Default power level HIGH appears in the display at first press of the **POWER LEVEL** pad.

 Press the **POWER LEVEL** pad or **DEFROST** pad one or more times until you get the desired power level.

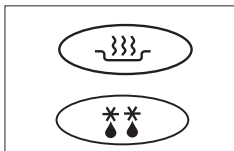
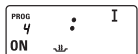

4. Press **NUMBER** pads to set the cooking time.

 The maximum time according to each cooking power level can be referred to in the title "Power Levels and Time Variations" on page 7. The **NUMBER** pads will not operate or respond when you press a cooking time exceeding the maximum value. It is not possible to set a cooking time for longer than the maximum time allowed on the chosen program. It is advisable to press **CANCEL** and to enter a new power level and cooking time.



5. Repeat steps 3 and 4 for II or III stage memory programming.

6. Hold down **PROGRAM LOCK** (○) and then press **PROGRAM (P)** pad. Hold together for 2 sec once again.

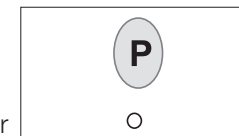

**Result :** **PROG** indicator and memory number indicator blink 3 times in the digital display with a beep sound. And then the display goes blank.

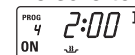

Caution: Be sure to press the pads firmly in the right position.



7. When you want to program more, repeat the procedures above again.

-  Memory programs are available up to 30 items. Make sure the unit is properly programmed. After programming is finished, all you have to do for memory cooking is to press the **NUMBER** pad. Then the selected memory program automatically starts cooking.
-  You can not set up the same **POWER LEVEL** or **DEFROST**.
-  It operates as setting up sequence.

## HOW TO OPERATE MEMORY COOKING

After having finished memory programming, just press the NUMBER pad of the memory number you want to select. The oven will automatically start heating according to the pre-programmed cooking time and power level.

1. Make sure the oven is plugged into a properly earthed electrical outlet and "ON" appears in the display window.
2. Open the door.  
The oven lamp will be turned on.
3. Put the food into a suitable container, place it in the centre of the oven and then close the door securely.

**Result :** The oven lamp will go off.

4. Press **NUMBER** pad.

**Result :** The selected memory program automatically starts heating. But, **NUMBER** pad 1, 2, 3 operate after 2 seconds.



## HOW TO OPERATE DOUBLE QUANTITY PAD

1. Press the **Double Quantity** pad.

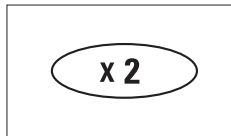

2. Press the desired memory **NUMBER** pad.

**Result :** Cooking time which was multiplied by the preset factor appears in the display and cooking starts with time digits counting down.

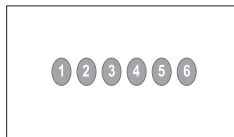

You don't need to press (◊) button to start heating.

## DOUBLE QUANTITY PAD PROGRAMMING

1. Hold down (Ⓢ) and then press (x2) pad. Hold together for 2 seconds.

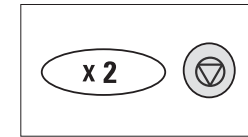

2. Select desired program code by using **NUMBER** pads.



3. Press **NUMBER** pads to set the magnification factor within the range from 1.00 to 9.99.







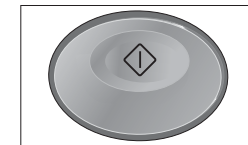



Default factor is 1.65 preset from the manufacturer for increasing the cooking time. Make sure that you set a correct factor between 1.00 and 9.99 for each memory code number.

4. Press (◊) button.

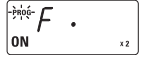
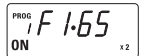

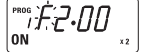
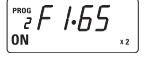
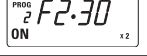
Press pad to exit the programming mode. Though you can successfully set a double quantity factor whose setting might result in excess of the maximum time allowed for each power level, the oven does not operate exceeding the maximum time.

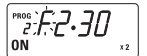
### Double Quantity Factor Editing

Feature	Key Entry	Display	Remark
Double Quantity Factor Edit	Hold down CANCEL (  ) and then (  ) pad.		Hold down for 2 sec.
	Code No.		After 1 sec, default value shows in the display window.
	(Input desired factor value.)		1.00 ~ 9.99 available (Change the factor if required.)
	START(  )		If you don't want to change more, press CANCEL to exit the editing mode.
	New Code No.		Skip this step if not necessary.
	(Input desired factor value.)		Skip this step if not necessary.
	START (  )		Skip this step if not necessary.
	CANCEL (  )	(Mode cancel)	This exits the editing mode.

### CONTROLLING BEEP TONE

You can select the beep tone you require. There are 4 sound levels available.

Hold down **CANCEL** (  ) and then press **NUMBER** 0 pad. Hold together for 2 seconds.

**Result :** Beep tone is changed to one level higher than current one.

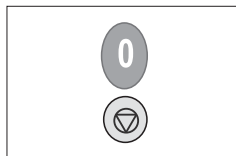

 Beep tone 0 does not make beep sound.

Settings are circulating whenever you press the hidden keys in the following order.

Snd 0 → Snd 1 → Snd 2 → Snd 3 → Snd 0 (No sound)

 Default tone is Snd 2.

### PROGRAMMING AIR FILTER CLEAN TIME

When the air filter check indicator (**FILTER**) appears in the display window after a certain time of use, you should clean the air filter according to the instructions “Cleaning the Air Filter” on page 16 in this booklet. Then follow the procedure as below if you want to change the air filter clean time.

1. Hold down **PROGRAM LOCK** (  ) and then press **NUMBER 3** pad. Hold together for 2 seconds.



**Result :** The display will show the length of time in hours between cleaning the air filter you have programmed in or the original time preset by the manufacturer.

 Default clean time is 500 hours in terms of pure oscillating time, not the continuity time.

2. Press **NUMBER** pads to set the desired clean time.



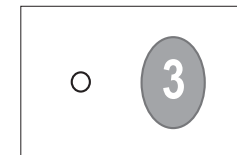

 You can set up to 999 hours.

3. Hold down **PROGRAM LOCK** (  ) and then press **NUMBER 3** pad. Hold together for 2 seconds in order to save the new value. This completes the programming of the air filter clean time.

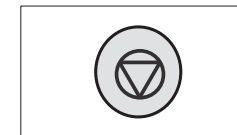

4. Press **CANCEL** (  ) pad to return to cooking mode.



 After the clean time has expired, you should clean the air filter. See page 17.

## ERROR CODES

Error Items	Code	Error Beep	Cause	Remedy
<b>Power frequency Error (50/60Hz)</b>	E1	-	Power frequency is other than 50 Hz.	Unplug the power cord plug and check if the power frequency is 50 Hz. Plug the power cord in 50 Hz power source and see if "E1" appears. If the error code is displayed again even after the correct power source is provided, contact the nearest service centre.
<b>HVT-I Power Error</b>	E41	One long beep for 2 sec	The circuitry inside the oven is not working correctly.	Unplug the power cord and wait for 10 seconds. Plug the power cord in again and check if the error code "E41" appears again. If the symptom persists, contact the nearest service centre.
<b>HVT-II Power Error</b>	E42	One long beep for 2 sec	The circuitry inside the oven is not working correctly.	Unplug the power cord and wait for 10 seconds. Plug the power cord in again and check if the error code "E42" appears again. If the symptom persists, contact the nearest service centre.
<b>EEPROM Error</b>	E5	One long beep for 2 sec	Memory IC (EEPROM IC) is not working correctly. In this case, other features except for memory function work properly. (You can operate the oven manually)	Press CANCEL pad one or more times and try to start a memory heating. If the error code "E5" persists, contact your nearest service centre.

## HIDDEN KEYS

Note: Press Key 1 and then the next one. Hold for 2 secs.

Feature	Key Entry		Display	Remark
	Key 1	Next		
<b>Continuity time total</b>	CANCEL (⊖)	1		Hold together for 2 sec. Unit: 10 hrs.
<b>Magnetron oscillating time total</b>	CANCEL (⊖)	2		Hold together for 2 sec. Unit: 1 hr.
<b>Number of times of use by memory program code</b>	CANCEL (⊖)	START		Hold together for 2 sec.
	Code No.			
	(Data display after 2 sec.)			739 times of use
	(New code can be set after data display)			
CANCEL (⊖)			(Mode cancel)	
<b>Heating time per memory program code (Automatic sequential display)</b>	CANCEL (⊖)	( P )		Hold together for 2 sec.
			(Sequentially displays for 3 sec from 1 to 30)	
	CANCEL (⊖)		(Mode Cancel)	



## CARE OF YOUR MICROWAVE OVEN

Cleaning the Microwave Oven

1. Unplug the oven from the electrical socket before cleaning.
2. Clean the inside of the oven. Wipe up all spills with a damp cloth. Kitchen detergent solution may be used if the oven gets too dirty. Do not use harsh detergents or abrasives.
  - If food remnant or spilled liquids stick to the oven walls, or between door seal and door surface, they will absorb microwaves possibly resulting in arcing or sparks.
3. Clean the outside of the oven with soap and water, then dry with a soft cloth.
 

**Caution:** Make sure that water does not get into the back ventilation or control panel opening.
4. When you clean the window of the door, be sure to use a soft cloth after washing with very mild soap and water. Do not use window cleaner as the front door can be scratched by harsh soap or cleaners.

## CLEANING THE CEILING COVER

1. Hold side stoppers of ceiling cover with both hands and pull them in and down. Then take the ceiling cover out of the oven cavity.
2. Rinse ceiling cover in soapy water or Food Sanitizer Solution.
3. Be sure to replace the ceiling cover before using the oven.

**CAUTION :** Ceiling cover must be in place securely when you use the oven. When you removed the Ceiling Cover for the purpose of cleaning, be sure to be extremely careful about the exposed inside components on the top of the oven cavity. If any of them are deformed, abnormal symptom can happen such as arcing or sparks during operation. In case of such problem, contact the nearest after-sales service centre.

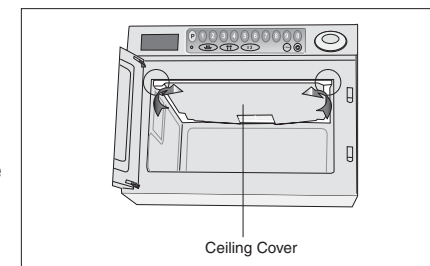

## CLEANING THE AIR FILTER

Clean the Air Filter regularly according to the following instructions. The oven may have problems when the Air Filter becomes clogged with dust.

1. Remove the bolt at both ends of the Air Filter.
2. Lift the Air Filter off the post carefully.
3. Wash this filter in warm soapy water.
4. Be sure to replace the Air Filter before using the oven.

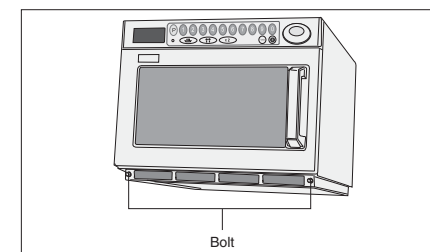

- If the Air Filter becomes clogged with debris, this will cause an overheating problem on the oven.
- If the want to change the air filter clean time, refer to “Programming Air Filter Clean Time” in page 15.

## INSTALLATION INSTRUCTIONS FOR STACKING

### Important

1. Disconnect the power cord from the wall socket before attempting installation.
2. For stacking installation, you must use the “bracket plate” which is enclosed with this unit.
3. The maximum stacking height is two units.

 Stacking the two units is limited to the following models.

**CAUTION :** Be sure the oven cavity is empty.

### Installation

1. Stack two units together.
2. Remove 6 screws as shown in the figure.
3. Place the Bracket-plate to join the two units.
4. Attach and tighten 6 screws as shown in the figure here.
5. Ensure the top oven is at a safe and workable height.

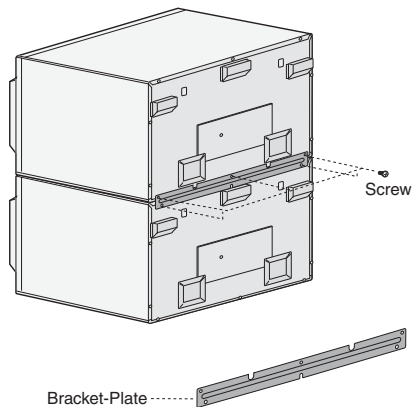

## REPLACEMENT OF LAMP

### Important

1. Remove a screw securing the lamp cover.
-  You don't need to remove outer panel to replace lamp.
2. Remove the lamp by rotating it clockwise.
  3. Replace with a new lamp by rotating it counter-clockwise.

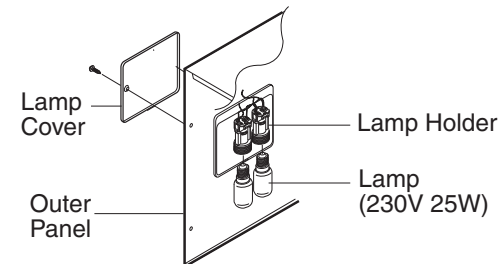

## COOKWARE GUIDE

To cook food in the microwave oven, the microwaves must be able to penetrate the food, without being reflected or absorbed by the dish used. Care must therefore be taken when choosing the cookware. If the cookware is marked microwave-safe, you do not need to worry. The following table lists various types of cookware and indicates whether and how they should be used in a microwave oven.

Cookware	Microwave-Safe	Comments
<b>Aluminum foil</b>	✓ X	Can be used in small quantities to protect areas against overcooking. Arcing can occur if the foil is too close to the oven wall or if too much foil is used.
<b>China and earthenware</b>	✓	Porcelain, pottery, glazed earthenware and bone china are usually suitable, unless decorated with a metal trim.
<b>Disposable polyester cardboard dishes</b>	✓	Some frozen foods are packaged in these dishes.
<b>Fast-food packaging</b>		
• Polystyrene cups containers	✓	Can be used to warm food. Overheating may cause the polystyrene to melt.
• Paper bags or newspaper	X	May catch fire.
• Recycled paper or metal trims	X	May cause arcing.
<b>Glassware</b>		
• Oven-to-tableware	✓	Can be used, unless decorated with a metal trim.
• Fine glassware	✓	Can be used to warm foods or liquids. Delicate glass may break or crack if heated suddenly.
• Glass jars	✓	Must remove the lid. Suitable for warming only.

Cookware	Microwave-Safe	Comments
<b>Metal</b>		
• Dishes	X	May cause arcing or fire.
• Freezer bag twist ties	X	
<b>Paper</b>		
• Plates, cups, napkins and Kitchen paper	✓	For short cooking times and warming. Also to absorb excess moisture.
• Recycled paper	X	
<b>Plastic</b>		
• Containers	✓	Particularly if heat-resistant thermoplastic. Some other plastics may warp or discolour at high temperatures. Do not use Melamine plastic.
• Cling film	✓	
• Freezer bags	✓ X	Can be used to retain moisture. Should not touch the food. Take care when removing the film as hot steam will escape.
		Only if boilable or oven-proof. Should not be airtight. Prick with a fork, if necessary.
<b>Wax or grease-proof paper</b>	✓	Can be used to retain moisture and prevent spattering.

✓ : Recommended

✓X : Use Caution

X : Unsafe

## Cooking Guide

**F : Frozen**

**C : Chilled**

Recipe	Method	Power Level	Timing			Stand Time
			1850W	1500W	1300W	
<b>BREAD &amp; PASTRIES</b>						
<b>To Defrost</b>						
Vienna Baton 9" F		DEFROST 1 (☼☼)	0'45"	0'50"	0'50"	5 mins
Vienna Baton 9" X 2 F		DEFROST 1 (☼☼)	1'10"	1'15"	1'20"	5 mins
Gateaux, ind. Slice F	Place on plate	DEFROST 2 (☼)	2'30"	2'40"	2'50"	5 mins
<b>To warm</b>						
Quiche 11" sliced 136g	Place on plate	DEFROST 1 (☼☼)	3'00"	3'00"	3'00"	1 min
		HIGH	0'40"	0'45"	0'50"	1 min
Mince pies ind. X 2 F	Remove from tin foil Place on plate	HIGH	0'10"	0'15"	0'15"	1 min
Fruit pie F	Place on plate	HIGH	0'40"	0'45"	0'45"	1 min
Croissant X 2 F	Place on plate	HIGH	0'05"	0'10"	0'10"	1 min
Pastry, baked 227g C	Place on plate	HIGH	0'45"	0'55"	1'00"	1 min
Chicken & mushroom pie X 2 C	Remove foil. Place on plate	HIGH	0'45"	0'55"	1'00"	1 min
Chicken & mushroom pie C	Place on plate, remove foil	HIGH	0'30"	0'40"	0'45"	1 min

Recipe	Method	Power Level	Timing			Stand Time
			1850W	1500W	1300W	
<b>SNACK &amp; STARTERS</b>						
<b>To cook</b>						
Bacon, rasher C	Place on rack	HIGH	1'30"	1'40"	1'50"	1 min
Eggs, poached X 2 C	Place in ramekins	HIGH	0'30"	0'40"	0'45"	1 min
Eggs, scrambled X 2 C	Beat eggs and place in bowl	HIGH	25"-30"	30"-40"	35"-45"	1 min
Sausages X 2 Thick C	Pierce	MED	1'00"	1'10"	1'20"	2 mins
<b>To Reheat</b>						
Sausages Cumberland F	Place on plate	MED	2'00"	2'10"	2'20"	2 mins
Full breakfast C	Cover	MED	2'30"	2'40"	2'50"	1 min
Beefburgers F		HIGH	0'55"	1'05"	1'10"	1 min
Chickenburger F		HIGH	0'55"	1'05"	1'10"	1 min
Donner kebab 162g F		HIGH	1'00"	1'10"	1'20"	1 min
Hot Dog F		HIGH	1'00"	1'10"	1'20"	1 min
Pizza 190g F	Place on plate	LOW	2'30"	2'45"	3'00"	2 min
Chargrilled ribs 200g F	Place on plate	MED	3'30"	3'45"	4'00"	1 min
Wings of fire X 6 F	Arrange on plate, thin parts to center	HIGH	2'00"	2'15"	2'30"	1 min
Baked Beans 500g	Cover and Stir half way	HIGH	2'00"	2'10"	2'20"	2 mins
Baked Beans 250g	Cover and Stir half way	HIGH	1'00"	1'05"	1'10"	2 mins

ENGLISH

**F : Frozen****C : Chilled**

Recipe	Method	Power Level	Timing			Stand Time
			1850W	1500W	1300W	
<b>DESSERTS</b>						
<b>To warm</b>						
Apple Crumble 200g F	Cover in dish	HIGH	1'20"	1'30"	1'40"	2 mins
Christmas Pudding 150g C	Place in bowl	HIGH	0'20"	0'25"	0'30"	2 mins
Jam Roly Poly 80g F	On a plate	HIGH	1'00"	1'05"	1'10"	2 mins
Crepes Suzette 2 F	Pierce film	HIGH	0'50"	1'00"	1'10"	1 min
Suet Sponge pudding F	X 2 X 1	HIGH	0'35"	1'05"	1'30"	2 mins
		HIGH	0'40"	0'50"	1'00"	2 mins
Sponge pudding F	X 2 X 1	HIGH	0'35"	1'05"	1'30"	2 mins
		HIGH	0'40"	0'45"	0'45"	2 mins
<b>RECIPE DISH ENTREES</b>						
<b>To Reheat</b>						
Amorini & Stilton bake C	Place in microwave safe dish	HIGH	3'30"	3'40"	3'50"	1 min
Chicken Tikka masala F	Pierce film	HIGH	3'20"	3'30"	3'40"	2 mins
Thai Green Chicken curry F	Pierce film	HIGH	3'00"	3'15"	3'30"	2 mins
Chilli con Carne F	Pierce film	HIGH	3'30"	3'45"	4'00"	2 mins
Chicken cooked 1/2 Chilled	Place in m/w in pierced bag	MED	4'30"	5'00"	5'30"	2 mins

Recipe	Method	Power Level	Timing			Stand Time
			1850W	1500W	1300W	
Lasagne 192g	Place in microwave safe dish	MED	4'00"	4'15"	4'30"	2 mins
Moules Marinieres 466g F	Pierce bag	HIGH	2'30"	2'45"	3'00"	2 mins
Salmon & Avacodo Paupiette C	Pierce bag	HIGH	2'30"	2'45"	3'00"	2 mins
Shepherd's pie 300g C	Place in oven and cover	MED	3'00"	3'15"	3'30"	2 mins
Suet puddings chilled	Cover - place upright on microwave safe plate	LOW	4'00"	4'20"	4'40"	2 mins
Supreme of chicken in red pesto 312g F	Pierce bag place on plate	DEFROST 1 (**)	5'00"	5'00"	5'00"	1 min
		HIGH	3'30"	3'45"	4'00"	
Tagliatelle carbonara C	Pierce film, place on plate	HIGH	1'40"	2'00"	2'20"	1 min
Tortellini formaggio C	Place in dish and cover	HIGH	2'00"	2'15"	2'30"	1 min
Vegetable Cumberland Pie C	Place in microwave safe dish	HIGH	3'20"	3'35"	3'50"	1 min
Plated Meal 350g C	Covered	HIGH	2'00"	2'15"	2'30"	1 min
Plated Meal 700g C	Covered	HIGH	3'00"	3'15"	3'30"	1 min

**F : Frozen**

**C : Chilled**







Recipe	Method	Power Level	Timing			Stand Time
			1850W	1500W	1300W	
<b>FRESH VEGETABLES</b>						
<b>To cook 500g</b>						
Beans, green sliced	60ml/4tbsps water cover	HIGH	3'00"	3'15"	3'30"	2 mins
Broccoli, florets	60ml/4tbsps water cover	HIGH	3'00"	3'15"	3'30"	2 mins
Cabbage, shredded	10tbsps water cover	HIGH	5'00"	5'30"	6'00"	2 mins
Carrots, sliced	60ml/4tbsps water cover	HIGH	3'30"	3'45"	4'00"	2 mins
Cauliflower, florets	60ml/4tbsps water cover	HIGH	3'30"	3'45"	4'00"	2 mins
Whole Green beans	60ml/4tbsps water cover	HIGH	3'30"	3'45"	4'00"	2 mins
Potatoes, jacket	Turn half way	HIGH	10'00"	11'00"	12'00"	5 mins
Sprouts	60ml/4tbsps water cover	HIGH	4'30"	4'45"	5'00"	2 mins
Beans, green sliced	Cover, stir half way through cooking	HIGH	3'00"	3'15"	3'30"	2 mins
Beans, whole	Cover, stir half way	HIGH	4'00"	4'15"	4'30"	2 mins
Broccoli Florets	Cover, stir half way	HIGH	4'00"	4'15"	4'30"	2 mins
Cabbage, shredded	Cover, stir half way	HIGH	4'00"	4'15"	4'30"	2 mins
Carrot batons	Cover, stir half way	HIGH	4'00"	4'15"	4'30"	2 mins
Cauliflower, florets	Cover, stir half way	HIGH	4'00"	4'15"	4'30"	2 mins
Corn on the Cob	Cover	HIGH	4'00"	4'30"	5'00"	2 mins

Recipe	Method	Power Level	Timing			Stand Time
			1850W	1500W	1300W	
Corn, whole baby	Cover, stir half way	HIGH	5'00"	3'15"	3'30"	2 mins
Mushrooms, whole	Cover, stir half way	HIGH	3'00"	3'15"	3'30"	2 mins
<b>FRESH VEGETABLES</b>						
<b>To cook 500g</b>						
Potatoes, jacket 230~290g X 1		HIGH	3'00"	4'00"	4'30"	2 mins
Potatoes, Mashed X 2		HIGH	6'00"	6'30"	7'00"	2 mins
Potatoes, Mashed X 4		HIGH	10'00"	11'15"	12'30"	2 mins
Ratatouille 500g		HIGH	3'30"	4'00"	4'30"	2 mins
Sprouts	Cover, stir half way	HIGH	3'00"	3'30"	4'00"	2 mins
<b>RICE, 500g</b>						
<b>To Reheat</b>						
Rice, boiled F	Cover, stir half way	HIGH	3'00"	3'15"	3'30"	2 mins
Rice, Pilau F	Cover, stir half way	HIGH	3'00"	3'15"	3'30"	2 mins

ENGLISH

## CLEANING YOUR MICROWAVE OVEN

The following parts of your microwave oven should be cleaned regularly to prevent grease and food particles from building up:

- Inside and outside surfaces
  - Door and door seals
  - Plate tray
-  **ALWAYS** ensure that the door seals are clean and the door closes properly.
-  Failure to maintain the oven in a clean condition could lead to deterioration of the surface that could adversely affect the of the appliance and possibly result in a hazardous situation.
1. Clean the outside surfaces with a soft cloth and warm, soapy water. Rinse and dry.
  2. Remove any splashes or stains on the inside surfaces or on the roller ring with a soapy cloth. Rinse and dry.
  3. To loosen hardened food particles and remove smells, place a cup of diluted lemon juice on the turntable and heat for ten minutes at maximum power.
-  **DO NOT** spill water in the vents.
-  **NEVER** use any abrasive products or chemical solvents.
-  Take particular care when cleaning the door seals to ensure that no particles:
- Accumulate
  - Prevent the door from closing correctly
-  **Clean the** microwave oven cavity right after each use with a mild detergent solution, but let the microwave oven cool down before cleaning in order to avoid injury.

## STORING AND REPAIRING YOUR MICROWAVE OVEN

A few simple precautions should be taken when storing or having your microwave oven serviced.

The oven must not be used if the door or door seals are damaged:

- Broken hinge
- Deteriorated seals
- Distorted or bent oven casing

Only a qualified microwave service technician should perform repair.

 **NEVER** remove the outer casing from the oven. If the oven is faulty and needs servicing or you are in doubt about its condition:

- Unplug it from the wall socket
- Contact the nearest after-sales service centre

 Contact SAMSUNG WORLD WIDE.

If you have any questions or comments relating to Samsung products, please contact the SAMSUNG customer care centre. Samsung Electronics U.K. Ltd. Unit C, Stafford Park 12 Telford, Shropshire TF3 3BJ The United Kingdom.

Tel : 0870 242 0303. Fax : 01952 297617.

Web Site : [www.samsung.com/uk](http://www.samsung.com/uk)



## TECHNICAL SPECIFICATIONS

SAMSUNG strives to improve its products at all times. Both the design specifications and these user instructions are thus subject to change without notice.

By right of the common regulation 2/1984 (III.10) BKM-IpM. we as distributors testify, that the **CM1929A CM1529A CM1329A** ovens of Samsung comply with the undermentioned technological parameters.

Model	CM192A	CM1529A	CM1329A
Power source	230 V ~ 50 Hz		
Power consumption Microwave	3000 W	3200 W	2600 W
Output power	1850 W (IEC-705)	1500W (IEC-705)	1300W (IEC-705)
Operating frequency	2,450 MHz		
Dimensions (W x H x D)			
Outside	464 x 368 x 557 mm		
Oven cavity	370 x 190 x 370 mm		
Volume	26 liter		
Weight Net	32 kg approx		
Noise level	54.5 dB		

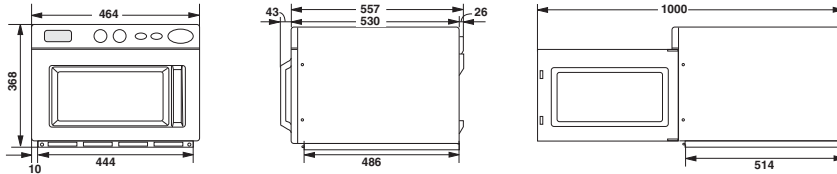

## NOTE



**If you have any problems with your machine please can you contact  
Samsung Customer Support Center**

**PO Box 479  
Gateshead  
NE9 9BJ**

**Code No.: DE68-04030B**